

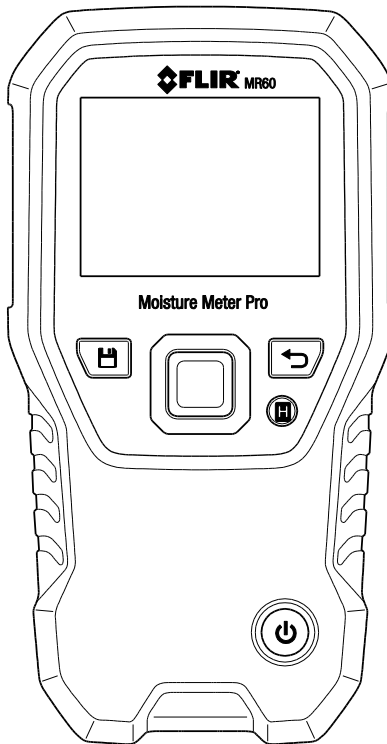

# FLIR MODEL MR60

# MOISTURE METER PRO



# Table of Contents

---

<b>1. DISCLAIMERS</b>	<b>4</b>
1.1 Copyright	4
1.2 Quality Assurance	4
1.3 Documentation	4
1.4 Disposal of Electronic Waste	4
<b>2. SAFETY</b>	<b>5</b>
2.1 Safety Notes	5
2.2 Safety Symbols	5
<b>3. INTRODUCTION</b>	<b>6</b>
3.1 Key Features	6
<b>4. METER DESCRIPTIONS</b>	<b>7</b>
4.1 Meter Description	7
4.2 Control Button Descriptions	8
4.3 Main Menu Overview	8
<b>5. OPERATION</b>	<b>9</b>
5.1 Powering the Meter	9
5.1.1 Auto Power OFF (APO)	9
5.2 Moisture Measurements	9
5.2.1 Moisture Measurement Overview	9
5.2.2 Moisture Display Overview	10
5.2.3 Moisture Menu	10
5.2.4 External Pin Probe Moisture Measurements	11
5.2.5 Internal Moisture Sensor Measurements (Pinless)	11
5.2.6 Reference Mode Moisture Measurements	12

5.3	Screen Capture and Data Acquisition	12
5.3.1	Screen Capture and Review	12
5.3.2	Data Acquisition	12
5.4	High Moisture Alarm	13
5.5	SETTINGS Menu	14
<b>6.</b>	<b>MAINTENANCE</b>	<b>15</b>
6.1	Cleaning	15
6.2	Battery Charging	15
6.2.1	Disposal of Electronic Waste	15
6.3	Updating the MR60 firmware	16
<b>7.</b>	<b>SPECIFICATIONS</b>	<b>17</b>
7.1	General Specifications	17
7.2	Moisture Meter Specifications	18
<b>8.</b>	<b>TECHNICAL SUPPORT</b>	<b>18</b>
<b>9.</b>	<b>MATERIAL GROUPS</b>	<b>19</b>
9.1	Common Names of Timbers (BS888/589:1973) with MR60 Group Nos.	19
9.2	Botanical names of timbers with MR60 program group numbers	21
9.3	%WME Table (% Wood Moisture Equivalent)	23
<b>10.</b>	<b>WARRANTY</b>	<b>24</b>
10.1	FLIR Test & Measurement 2-Year Limited Warranty	24

# 1. Disclaimers

---

## 1.1 Copyright

© 2016 FLIR Systems, Inc. All rights reserved worldwide. No parts of the software including source code may be reproduced, transmitted, transcribed or translated into any language or computer language in any form or by any means, electronic, magnetic, optical, manual or otherwise, without the prior written permission of FLIR Systems.

The documentation must not, in whole or part, be copied, photocopied, reproduced, translated or transmitted to any electronic medium or machine readable form without prior consent, in writing, from FLIR Systems.

Names and marks appearing on the products herein are either registered trademarks or trademarks of FLIR Systems and/or its subsidiaries. All other trademarks, trade names or company names referenced herein are used for identification only and are the property of their respective owners.

## 1.2 Quality Assurance

The Quality Management System under which these products are developed and manufactured has been certified in accordance with the ISO 9001 standard.

FLIR Systems is committed to a policy of continuous development; therefore we reserve the right to make changes and improvements on any of the products without prior notice.

## 1.3 Documentation

To access the user manuals, extended warranty registration, firmware updates, and notifications go to the Download tab at: <http://support.flir.com>. In the download area you will also find the latest releases of manuals for our other products, as well as manuals for our historical and obsolete products. The extended warranty page can also be found at [www.Flir.com/testwarranty](http://www.Flir.com/testwarranty).

## 1.4 Disposal of Electronic Waste



As with most electronic products, this equipment must be disposed of in an environmentally friendly way, and in accordance with existing regulations for electronic waste.



Please contact your FLIR Systems representative for more details.





## 2. Safety

---

### 2.1 Safety Notes

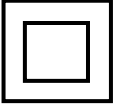
- Before operating the device, you must read, understand, and follow all instructions, dangers, warnings, cautions, and notes.
- FLIR Systems reserves the right to discontinue models, parts or accessories, and other items, or to change specifications at any time without prior notice.

### 2.2 Safety Symbols

	UL listed
	Double insulation protection
	European Community compliance
	Electronic Waste disposal restrictions
	This symbol, adjacent to another symbol, indicates the user must refer to the user manual for further information.

#### Agency Approvals:



UL listing is not an indication or a verification of the accuracy of the meter

### 3. Introduction

---

Thank you for selecting the FLIR MR60 Moisture Meter Pro. The FLIR MR60 Moisture Meter Pro is an easy-to-use pin and pinless moisture meter with advanced functionality to meet all your professional measurement needs. An integrated pinless sensor and an external pin probe (MR02) provide the flexibility to take either destructive or non-destructive measurements. You can select one of the eleven material groups for pin moisture, or set a reference point for fast pinless moisture scanning. The MR60 is also compatible with FLIR's full line of external moisture probes, so you have the flexibility to expand your meter as needed (Please see [www.flir.com/test](http://www.flir.com/test) for additional accessories available for this device). Conveniently save screenshots of your measurements and as a CSV file with the date, time, and settings. The bright, color screen and bargraph makes readings clear and easy to see. Built portable and durable enough to withstand a 3-meter drop, you can take MR60 with you anywhere – even to your toughest jobs.

Please register the FLIR MR60 within 60 days of purchase for extended warranty at [www.flir.com/testwarranty](http://www.flir.com/testwarranty)

This device is shipped fully tested and calibrated and, with proper use, will provide years of reliable service.

#### 3.1 Key Features

- Quickly scan for moisture using the integrated non-invasive pinless moisture sensor
- External pin probe (included) for resistive moisture content measurements
- Pin or Pinless moisture readings are displayed with large digits and color bargraph
- Save up to 10,000 screens shots and readings that you can transfer, view, & via PC / USB
- Eleven (11) material group selections for pin-based readings
- Programmable high moisture alarm with audible and color visual alerts
- Easy to read color display and intuitive interface with helpful function labels in local languages
- File management & report generation with free FLIR Tools PC software
- Internal rechargeable battery with USB based international charger
- Durable, 3m drop tested and Portable for everyday use on the go
- Optional probe accessories for application specific needs

**Register for Extended Warranty:** [www.Flir.com/testwarranty](http://www.Flir.com/testwarranty)

## 4. Meter Descriptions

### 4.1 Meter Description

1. Color Graphical Display
2. Capture button stores reading and screen shot
3. Four (4) Navigation buttons (ring)
4. Select button (center)
5. Back button
6. Hold button
7. Power button
8. USB, external probe jack, and charge LED
9. Internal Pinless Moisture sensor (back)
10. Micro USB cable jack
11. External probe jack (RJ45)
12. Charging LED

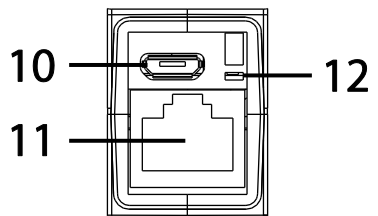
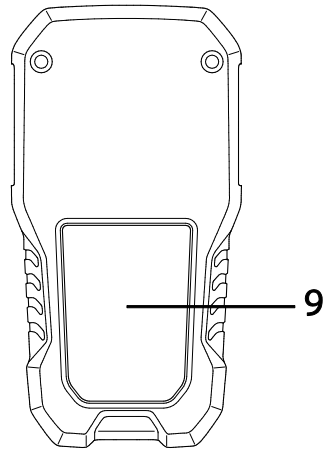
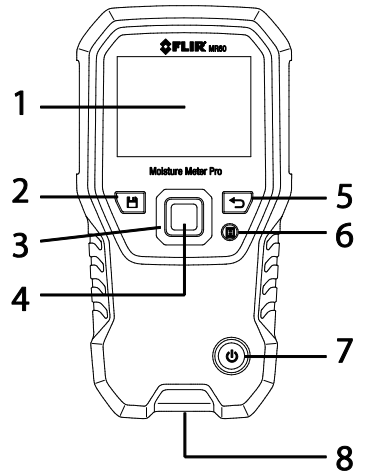







Fig. 4-1 Meter Description

## 4.2 Control Button Descriptions

	Capture button. Save a reading to internal CSV file and store a screen shot.
	Back button. Back up or return from a menu screen.
	Hold Button (freezes reading on the display)
	Press to power ON. Press and hold to power the meter OFF.
	Press the Select button (center) to access the Main Menu. Use this button to select items from within the menu structure. Use the four outer (ring) buttons to navigate.

## 4.3 Main Menu Overview

The menu items are described briefly in this section. Detailed explanations for each item are provided in subsequent sections of this User Manual.

The Main Menu is shown in Fig. 4-2. Press the Select button to open the Main Menu and use the navigation buttons to move to the desired mode (Screen-shot review mode, Moisture mode, and Settings mode, left to right). Use the Back button to return from a sub-menu:

1. Screen-shot review mode (press Select to enter the mode and then use left/right navigation buttons to scroll through stored screen shots)
2. Moisture mode icon. Press Select to view the four Moisture menu items (Material group, Pin mode, Pinless mode, and Set Reference mode). Note that the Material group mode is only accessible when Pin mode is selected and the Set Reference function is only available when Pinless mode is selected.
3. Settings mode items: Language, High Alarm, Auto Power OFF, Date & Time, Meter Information, and Help contact screen.

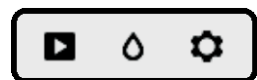

1 2 3

**Fig. 4-2** Main Menu



## 5. Operation

---

**Important Note:** Please charge the meter battery before first use. Instructions for battery charging are provided in Section 6.2.

### 5.1 Powering the Meter

1. Press the Power button  momentarily to switch the meter ON.
2. Press and hold the Power button for > 1 second to switch the meter OFF.
3. If the battery status indicator (upper left) shows that the battery voltage is low, or if the meter does not power on, charge the battery. See section 6.2 *Battery Charging*.
4. Please fully charge the battery before use.

#### 5.1.1 Auto Power OFF (APO)

The meter switches OFF automatically after a programmed period of inactivity (1, 5, or 20 minutes). Press any button to reset the APO timer. To disable APO, or to change the APO time-out value, use the Settings  mode, accessible from the Main Menu. The default time-out is 20 minutes.

### 5.2 Moisture Measurements

#### 5.2.1 Moisture Measurement Overview

Moisture measurements can be performed using either the internal pinless moisture sensor (rear) or by connecting an external probe. A standard external pin probe is included which connects to the MR60 via the jack at the bottom of the meter. Other external probes are available; please visit [www.flir.com/test](http://www.flir.com/test) for details.

**NOTE:** Objects in close proximity to the internal pinless moisture sensor (located on the rear of the unit) will affect the reading on the display; Keep hands and fingers clear of the sensor when taking measurements.

The internal moisture sensor detects moisture to a depth of approximately 19mm (0.75"). The actual depth will vary depending upon the amount of moisture, the material under test, surface roughness, and other factors.

Moisture readings are shown on the display (digitally and with bar graph). See Fig. 5-1. Pinless measurement readings are 'relative' scaled (0~100). Pin-based readings are represented in terms of %MC (moisture content); additional information is provided in Section 5.2.5 *External Pin Probe Moisture Measurements* and in the specifications.

Moisture measurements are covered in detail in the following sections. Be sure to select Pin Mode or Pinless Mode in the Moisture Menu to match the measurement type.

## 5.2.2 Moisture Display Overview

Moisture readings are displayed as shown in the example for Fig. 5-1.

1. Battery status icon
2. Moisture reading (digital)
3. Moisture reading in bargraph format; Bars are blue when in non-alarm state and red when in alarm state.
4. Set Reference value (see Set Reference mode in Sections 5.2.3 and 5.2.6); pinless mode only. Note that in Pin mode this display area will show the selected Material Group.
5. High Moisture Alarm threshold (see Section 5.4)
6. Selected Mode
7. DATA HOLD icon



Fig. 5-1 Moisture Mode Display

## 5.2.3 Moisture Menu

Icons 1, 2, 3, and 4 in Fig. 5-2 are shown in the Moisture Mode. Press Select to open the main menu and then choose the moisture icon  to view the Moisture modes. A blue dot is shown to the left of the pin icon (2) or the pinless icon (3), depending on which is selected. Use the Navigation buttons to highlight an icon and use the Select button to choose one.

### Material Groups

Select the material under test (Groups 1~11); For Pin Mode only. Select a Material group that best matches the material under test. This applies only for external pin-based probe use; Use the navigation buttons to scroll through the group list and use the Select button to choose the group. The selected group will show a blue dot. See the Material Group List Appendix in Section 9.

### Pin mode

The Pin mode must be selected when the external pin-based probe is used. Note the Pin icon on the main display when Pin mode is selected.

### Pinless mode

Pinless mode must be selected when using the internal (rear) sensor. Note the pinless icon on the main display when this mode is selected.

### Set Reference

Select this mode to store the current reading as a reference/comparator value (Pinless mode only).

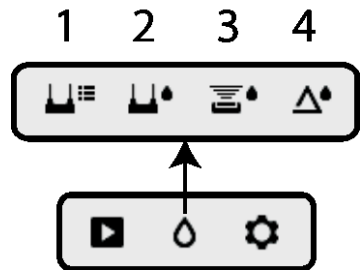

Fig. 5-2 Moisture mode icons

## 5.2.4 External Pin Probe Moisture Measurements



1. Follow the steps in Section 5.2.1 through 5.2.3 and select Pin mode from the MOISTURE mode options.
2. Connect the external pin probe to the meter's EXT jack on the bottom of the meter (under the protective flap). Refer to the FLIR website for information on available external pin moisture probe types.
3. Select the appropriate Material Group as described in Section 5.2.3 (see Section 9 for the Material Group Appendices). Note: Use Group 10 for brick, cement, screed, and concrete. Use Group 11 for cement mortar, anhydrite screed, and lime.
4. Press the pins into the material under test. When using Group 10 or Group 11 it is recommended that a conductive paste be used to ensure good contact.
5. The moisture reading is displayed on the main display (%) and as a bargraph, similar to the display example shown in Fig. 5-1.

### Notes on External Pin Probe Moisture measurements

*The MR60 will display accurate external pin probe readings in the 7% to 30% range, depending on the tested material. Moisture Content readings below 6% will display as 0% for all materials and the maximum specified range is dependent on the fiber saturation point for specific species. Above the fiber saturation point, the reading can only be used as a relative reference value.*

*For more information on fiber saturation please refer to ASTM D7438. For additional information on Pin moisture measurement accuracy please see ASTM D4444, section 6.*

### Notes on Material Groups 10 and 11

*Groups 10 and 11 provide basic moisture content estimations in the range of 0~20% (Group 10) and 0~9% (Group 11). These readings can be used to identify problem areas but should be verified using an RH-type concrete moisture meter per ASTM F2170. As such, even though the readings are presented in %MC by weight, they should be considered for reference only.*

## 5.2.5 Internal Moisture Sensor Measurements (Pinless)



1. Follow the steps in Section 5.2.1 through 5.2.3 and select the Pinless mode.
2. Place the internal moisture sensor (back) on the surface of the material to be tested. Apply light pressure to ensure that the internal sensor is completely flat against the surface of the material under test.
3. The relative moisture reading is displayed on the main display, digitally and as a color-coded bargraph (blue when not in an alarm state; red when in an alarm state). Refer to Fig. 5-1.
4. Keep hands, surfaces, and objects away from the rear internal moisture sensor area when taking measurements.
5. For best results, lift the meter off of the surface under test between measurement points; do not drag the meter over surfaces.

## 5.2.6 Reference Mode Moisture Measurements

1. Follow the steps in Section 5.2.1 through 5.2.3 and select SET REFERENCE from the MOISTURE mode options. This mode is only available for pinless measurements (internal sensor).
2. When the SET REFERENCE function is selected the Reference value and delta symbol are shown on the right side of the display, refer to example screen in Fig. 5-1.
3. Exit the menu Moisture Menu and begin taking readings.
4. Measurements taken now will be relative to the reference value. For example, if the reference value is '10' (representing the driest area of the material under test) and a measurement of '50' is taken (in an area with higher moisture content), the measurement line will show '40' ( $50 - 10 = 40$ ). This mode is useful for comparing wet areas to a dry area reference.
5. To remove the reference value and exit the mode: Remove the meter sensor from the area under test, so that the sensor is no longer touching a surface and is clear of any objects (keep hands away from the sensor), and then access the Moisture Menu and press the Set Reference icon again. The reference value will no longer be visible on the meter display. If there is difficulty removing the reference value from the display, ensure that nothing is coming into contact with the sensor when pressing the button.

## 5.3 Screen Capture and Data Acquisition

### 5.3.1 Screen Capture and Review

Pressing the **Capture** button saves the current MR60 screen shot. Pressing the Capture button also logs the current reading to an internal **log.csv** document (see Section 5.3.2). The screen will hold (freeze) momentarily until a file-name appears indicating that the screen shot has been saved.

Stored screen shots can be reviewed using the Image Review icon  available in the Main Menu; then scroll through the screen shots using the left/right navigation buttons.

Screen shots can be deleted by pressing the Select button while viewing a stored image (logged readings in the log.csv file are not deleted). A prompt will appear asking to 'Delete' or 'Cancel'. Choose 'Delete' to permanently discard the screen shot; choose 'Cancel' to keep it.

Screen shots can be transferred to computer or other compatible device using the MR60 USB port (bottom of meter, under flap) and supplied USB cable.

### 5.3.2 Data Acquisition

Pressing the **Capture** button logs the current reading to an internal **log.csv** document. Readings and reading type are saved along with date-time stamp to the **log.csv** file.

The log.csv file can be downloaded to a computer or other compatible device using the MR60 USB port (bottom of meter, under flap) and supplied USB cable. See Fig. 5-3 for an example log file.

	A	B	C	D	E	F	G	H
1	#	Date	Time	Reading	Type	Reference	Group	File
2	1	6/6/2015	12:00:44	33.7	Pinless Mode			FLIRO101.BMP
3								
4	#	Date	Time	Reading	Type	Reference	Group	File
5	1	12/10/2015	16:23:19	80.6	Pinless Mode			FLIRO102.BMP
6	2	12/10/2015	16:23:25	98.2	Pinless Mode			FLIRO103.BMP
7	3	12/10/2015	16:23:34	11.3	Pinless Mode	27.1		FLIRO104.BMP
8	4	12/10/2015	16:23:40	0	Pin Mode		Group 6	FLIRO105.BMP
9	5	12/10/2015	16:23:45	27.7	Pin Mode		Group 6	FLIRO106.BMP
10	6	12/10/2015	16:23:51	26.1	Pin Mode		Group 6	FLIRO107.BMP
11	7	12/10/2015	16:23:59	41.1	Pinless Mode	27.1		FLIRO108.BMP
12	8	12/10/2015	16:24:04	54	Pinless Mode	27.1		FLIRO109.BMP
13	9	12/10/2015	16:24:37	38.6	Pinless Mode			FLIRO110.BMP
14								
15	#	Date	Time	Reading	Type	Reference	Group	File
16	1	12/11/2015	9:52:02	76.8	Pinless Mode			FLIRO111.BMP
17	2	12/11/2015	9:52:18	0	Pinless Mode	73.5		FLIRO112.BMP
18	3	12/11/2015	9:52:23	7	Pinless Mode	73.5		FLIRO113.BMP
19	4	12/11/2015	9:52:33	18.2	Pinless Mode	79.7		FLIRO114.BMP
20	5	12/11/2015	9:52:47	0	Pinless Mode	74.7		FLIRO115.BMP
21	6	12/11/2015	9:53:01	8.7	Pinless Mode			FLIRO116.BMP
22	7	12/11/2015	11:14:30	61.5	Pinless Mode			FLIRO117.BMP
23	8	12/11/2015	11:14:41	66.1	Pinless Mode			FLIRO118.BMP

Fig. 5-3 Log file example

## 5.4 High Moisture Alarm

The MR60 offers a High Moisture Alarm where an audible and visual alert activates when the moisture reading exceeds the programmed high limit.

1. Press the Select button to access the Main Menu
2. Select the SETTINGS mode  from the Main Menu
3. Scroll to ALARM and press the Select button to open the Alarm programmer
4. Use the Navigation and Select buttons to switch the alarm ON or OFF and to set the threshold from 0% to 100%
5. Press the Select button to return to the SETTINGS mode and save the value or press the back button to cancel and to return to the normal operating mode
6. When the High Alarm is set ON, the main display will show the alarm bell icon and the High Alarm value. Refer to the example screen in Fig. 5-1.
7. When the measurement exceeds the threshold, the bargraph will turn red in color and the meter will beep.
8. To switch the alarm OFF when the meter is alarming, press the Select button twice. The meter will then be in the Settings mode where the alarm can be reprogrammed if desired.

## 5.5 SETTINGS Menu

Access the SETTINGS menu by pressing the Select button and choosing the Settings icon  .

The Settings menu options are described below:

1. **LANGUAGE.** In this mode the user can select the desired language for text displays. From the Settings menu, scroll to **Language** and press the Select button. The selected language will show a blue dot to its right. Use the four Navigation buttons to scroll to the desired language and then press the Select button to confirm. When the Select button is pressed to confirm, the meter will return to the Settings menu and will display in the newly selected language. Press the back button  at any time to cancel the language selection and return to the Settings menu.

The 14 available languages are: English, Czech, German, Spanish, French, Italian, Japanese, Korean, Dutch, Polish, Portuguese, Russian, Chinese, and Finnish

2. **ALARM.** Set a high alarm threshold. From the Settings menu, scroll to **Alarm** and press the Select button. Use the up/down navigation buttons to arm/disarm the alarm (ON/OFF). Use the left/right navigation buttons to select an alarm threshold digit; use the up/down navigation buttons to set the high alarm threshold. Refer to Section 5.7 for Alarm details. The Alarm can be used in pin or pinless mode of operation. Press the Select button to save the value and return to the SETTINGS menu or press the back button to cancel and return to the Settings menu.
3. **AUTO POWER OFF.** From the SETTINGS menu, scroll to **Auto Power OFF** and then use the Select button to step through the available options (1, 5, 20 minutes, or OFF). Navigate to another Settings option or press the back button to exit the Settings menu.
4. **DATE & TIME.** From the SETTINGS menu, scroll to **Date & Time** and press the Select button. Use the left/right navigation buttons to select YYYY (year), MM (month), DD (day), HH (hour): MM (minutes), from left to right, and use the up/down navigation buttons to change the digits. Press the Select button to save the value and return to Settings menu or press the back button to cancel and return to the normal operating mode.
5. **METER INFORMATION.** From the SETTINGS menu, scroll to **Meter Information** and press the Select button to view the Model, Software Version, and Last Calibration Date information. Press the back button to return to the Settings menu.

The next item is located on the 2<sup>nd</sup> page of the Settings menu; use the down navigation button to scroll down:

6. **HELP SCREEN.** Scroll to **HELP** and press the Select button to view the company contact information. Press the back button to return to the Settings menu.

## **6. Maintenance**

---

### **6.1 Cleaning**

Clean the meter with a damp cloth and mild detergent; do not use abrasives or solvents.

### **6.2 Battery Charging**

1. The internal battery is not user serviceable.
2. Please charge the battery before first use.
3. Connect the meter to an AC source or a computer USB port using the supplied USB charger cable. The USB port is located on the bottom of the meter, under the protective flap, next to the EXT Probe jack.
4. While the meter is charging, a blue LED (bottom of meter under protective flap) indicates that charging is successfully taking place.
5. View the battery status icon on the upper left hand corner of the meter's display when a program menu is active.

#### **6.2.1 Disposal of Electronic Waste**

As with most electronic products, this equipment must be disposed of in an environmentally friendly way, and in accordance with existing regulations for electronic waste.

Please contact your local FLIR Systems representative for more details.

## 6.3 Updating the MR60 firmware

The MR60 firmware can be updated in the field by the user, without the need for sending the unit in for service. If assistance is required, the user can contact a FLIR technical specialist (see Section 8). Firmware updates provide performance enhancements and new features and functions.

To update the firmware the following is required:

- Access to the website where the update file(s) are located: <http://support.flir.com>
- The MR60 to be updated
- The update files

Follow the steps below:

1. Visit [support.flir.com](http://support.flir.com) to check for the latest updates.
2. Login/Register for an account.
3. Select the 'Downloads' tab and then select 'Instrument Firmware' (Test and Measurement) from the drop down menu.
4. Select MR60 from the second drop down menu.
5. Select and download the updated firmware.
6. Follow the instructions in the download folder.
7. If there is an error, repeat the procedure. If a problem persists, contact FLIR technical support.



## 7. Specifications

---

### 7.1 General Specifications

Display	QVGA (320 x 240 pixel) 2.3" 64K color TFT graphical display
Internal memory	4GB; 9999 image storage capacity
Screen shot format	.bmp (bitmap) with measurement values overlaid
Stored data format	Comma Separated Values format (.csv) with time/date stamp, reading and reading type included
Power supply	3.7V, 2000mAh Li-ion integrated battery; rechargeable via micro USB
Power adaptor	100-240V AC input / 5V 1A output
Battery life	Included international charging plug set contains: A, A', C, E/F, G, I 18 hours continuous run-time, max.; typical usage: 4 work weeks
Auto Power OFF	Programmable: OFF, 1, 5, or 20 minutes
Low battery indicator	 is displayed in the Main Menu screen
Operating temperature	32~122 °F (0~50 °C)
Storage temperature	14~140°F (-10~60°C)
Operating humidity	≤ 90%, 32~86°F (0~30°C) ≤ 75%, 86~104°F (30~40°C) ≤ 45%, 104~122°F (40~50°C)
Storage humidity	90% RH
Dimensions (H x W x D)	5.5 × 2.9 × 1.7" (14 × 7.2 × 4.2 cm)
Product Weight	10.6 oz. (300g)
Drop test	9.8 ft. (3 m) drop test
IP Rating	IP54
Certification standards	EN61326 (EMC); EN61010 (battery and charger)
Agency approvals	CE, FCC Class B, UL, RCM
Included accessories	MR02 Standard Pin Probe, Quick Start Guide, International USB charger, and USB cable
Language options	Meter display text can be shown in any of fourteen (14) languages

## 7.2 Moisture Meter Specifications

Internal Pinless Sensor Measurements	0 ~ 100 (relative readings)
External Pin-based Measurements	Wood groups (1~9): 7% ~ 30%MC* ( $\pm 1.5\%$ MC*) 30% ~ 100%* (Reference Only) Construction material groups (10~11): 0 ~ 20% (reference only)
Measurement Resolution	0.1
Pinless Measurement Depth	0.75" (1.9cm) maximum
Sample rate	10Hz approximately (for pinless and pin modes)
Pin Moisture Groups	Nine (9) wood groups; Two (2) construction material groups
Response time	Pinless mode: 100ms Pin mode: 750ms

### Notes:

\* Maximum specified range is dependent on the fiber saturation point for specific species. Beyond this point, the reading can only be used as a relative reference value. For more information on fiber saturation please refer to ASTM D7438. Accuracy specification is based on the analysis in J. Fernández-Golfin et al. Actual real-world accuracy depends on a variety of factors; For more information, refer to ASTM D4444, section 6.

\*\*Accuracy spec. applies to pin probe moisture measurements taken on wood whose temperature is 20°C (68°F). Add 0.1% to the accuracy spec. for each °C below 20°C or subtract 0.1% for each °C above 20°C.

## 8. Technical Support

<b>Main Website</b>	<a href="http://www.flir.com/test">http://www.flir.com/test</a>
<b>Technical Support Website</b>	<a href="http://support.flir.com">http://support.flir.com</a>
<b>Technical support Email</b>	TMSupport@flir.com
<b>Service/Repair Support Email</b>	Repair@flir.com
<b>Support Telephone number</b>	+1 855-499-3662 option 3 (toll-free)
<b>Firmware Updates</b> To check for MR60 firmware updates please visit the technical support website (above) for complete installation instructions.	

## 9. Material Groups

### 9.1 Common Names of Timbers (BS888/589:1973) with MR60 Group Nos.

**Notes:**

Group 9 is for plywood, drywall, and oriented strand board (OSB)

Group 10 is for brick, cement screed, and concrete

Group 11 is for cement mortar, anhydrite screed, lime mortar, and plaster

Group 10 and 11 are not specified for accuracy and should be used for reference only

Abura	4	Gurjun	1	Pine, American Long Leaf	3
Afara	1	Hemlock, Western	3	Pine, American Pitch	3
Aformosa	6	Hiba	8	Pine, Bunya	2
Afzelia	4	Hickory	5	Pine, Caribbean Pitch	3
Agba	8	Hyedunani	2	Pine, Corsican	3
Amboyna	6	Iroko	5	Pine, Hoop	3
Ash, American	2	Ironbank	2	Pine, Huon	2
Ash, European	1	Jarrah	3	Pine, Japanese Black	2
Ash, Japanese	1	Jelutong	3	Pine, Kauri	4
Ayan	3	Kapur	1	Pine, Lodgepole	1
Baguacu, Brazilian	5	Karri	1	Pine, Maritime	2
Balsa	1	Kauri, New Zealand	4	Pine, New Zealand White	2
Banga Wanga	1	Kauri, Queensland	8	Pine, Nicaraguan Pitch	3
Basswood	6	Keruing	5	Pine, Parana	2
Beech, European	3	Kuroka	1	Pine, Ponderosa	3
Berlina	2	Larch, European	3	Pine, Radiata	3
Binvang	4	Larch, Japanese	3	Pine, Red	2
Birch, European	8	Larch, Western	5	Pine, Scots	1
Birch, Yellow	1	Lime	4	Pine, Sugar	3
Bisselon	4	Loliondo	3	Pine, Yellow	1
Bitterwood	5	Mahogany, African	8	Poplar, Black	1
Blackbutt	3	Mahogany, West Indian	2	Pterygota, African	1
Bosquiea	1	Makore	2	Pyinkado	4
Boxwood, Maracaibo	1	Mansonia	2	Queensland Kauri	8
Camphorwood, E African	3	Maple, Pacific	1	Queensland Walnut	3
Canarium, African	2	Maple, Queensland	2	Ramin	6
Cedar, Japanese	2	Maple, Rock	1	Redwood, Baltic (European)	1
Cedar, West Indian	8	Maple, Sugar	1	Redwood, Californian	2
Cedar, Western Red	3	Matai	4	Rosewood, Indian	1
Cherry, European	8	Meranti, Red (dark/light)	2	Rubberwood	7

Chestnut	3	Meranti, White	2	Santa Maria	7
Coachwood	6	Merbau	2	Sapele	3
Cordia, American Light	5	Missanda	3	Sen	1
Cypress, E African	1	Muhuhi	8	Seraya, Red	3
Cypress, Japanese (18-28%mc)	3	Muninga	6	Silky Oak, African	3
Cypress, Japanese (8-18%mc)	8	Musine	8	Silky Oak, Australian	3
Dahoma	1	Musizi	8	Spruce, Japanese (18-28%mc)	3
Danta	3	Myrtle, Tasmanian	1	Spruce, Japanese (8-18%mc)	8
Douglas Fir	2	Naingon	3	Spruce, Norway (European)	3
Elm, English	4	Oak, American Red	1	Spruce, Sitka	3
Elm, Japanese Grey Bark	2	Oak, American White	1	Sterculia, Brown	1
Elm, Rock	4	Oak, European	1	Stringybark, Messmate	3
Elm, White	4	Oak, Japanese	1	Stringybark, Yellow	3
Empress Tree	8	Oak, Tasmanian	3	Sycamore	5
Erimado	5	Oak, Turkey	4	Tallowwood	1
Fir, Douglas	2	Obeche	6	Teak	5
Fir, Grand	1	Odoko	4	Totara	4
Fir, Noble	8	Okwen	2	Turpentine	3
Gegu, Nohor	7	Olive, E African	2	Utile	8
Greenheart	3	Olivillo	6	Walnut, African	8
Guarea, Black	8	Opepe	7	Walnut, American	1
Guarea, White	7	Padang	1	Walnut, European	3
Gum, American Red	1	Padauk, African	5	Walnut, New Guinea	2
Gum, Saligna	2	Panga Panga	1	Walnut, Queensland	3
Gum, Southern	2	Persimmon	6	Wandoo	8
Gum, Spotted	1	Pillarwood	5	Wawa	6
				Whitewood	3
				Yew	3

## 9.2 Botanical names of timbers with MR60 program group numbers

<i>Abies alba</i>	1	<i>Eucalyptus acmenicides</i>	3	<i>Picea jezoensis</i> (8-18%mc)	8
<i>Abies grandis</i>	1	<i>Eucalyptus crebra</i>	2	<i>Picea sitchensis</i>	3
<i>Abies procera</i>	8	<i>Eucalyptus diversicolor</i>	1	<i>Pinus caribaea</i>	3
<i>Acanthopanax ricinifolius</i>	1	<i>Eucalyptus globulus</i>	2	<i>Pinus contorta</i>	1
<i>Acer macrophyllum</i>	1	<i>Eucalyptus maculate</i>	1	<i>Pinus lampertiana</i>	3
<i>Acer pseudoplatanus</i>	5	<i>Eucalyptus marginata</i>	3	<i>Pinus nigra</i>	3
<i>Acer saccharum</i>	1	<i>Eucalyptus microcorys</i>	1	<i>Pinus palustris</i>	3
<i>Aetoxicon punctatum</i>	6	<i>Eucalyptus obliqua</i>	3	<i>Pinus pinaster</i>	2
<i>Aformosia elata</i>	6	<i>Eucalyptus pilularis</i>	3	<i>Pinus ponderosa</i>	3
<i>Afzelia spp</i>	4	<i>Eucalyptus saligna</i>	2	<i>Pinus radiata</i>	3
<i>Agathis australis</i>	4	<i>Eucalyptus wandoo</i>	8	<i>Pinus spp</i>	2
<i>Agathis palmerstoni</i>	8	<i>Fagus sylvatica</i>	3	<i>Pinus strobus</i>	1
<i>Agathis robusta</i>	8	<i>Flindersia brayleyana</i>	2	<i>Pinus sylvestris</i>	1
<i>Amblygonocarpus andogensis</i>	1	<i>Fraxinus Americana</i>	2	<i>Pinus thunbergii</i>	2
<i>Amblygonocarpus obtusungulis</i>	1	<i>Fraxinus excelsior</i>	1	<i>Pipadeniastrum africanum</i>	1
<i>Araucaria angustifolia</i>	2	<i>Fraxinus japonicus</i>	1	<i>Piptadenia africana</i>	1
<i>Araucaria bidwilli</i>	2	<i>Fraxinus mardshurica</i>	1	<i>Podocarpus dacrydiodes</i>	2
<i>Araucaria cunninghamii</i>	3	<i>Gonystylus macrophyllum</i>	6	<i>Podocarpus spicatus</i>	3
<i>Berlinia grandiflora</i>	2	<i>Gossweilodendron balsamiferum</i>	8	<i>Podocarpus totara</i>	4
<i>Berlinia spp</i>	2	<i>Gossypiospermum proerox</i>	1	<i>Populus spp</i>	1
<i>Betula alba</i>	8	<i>Grevillea robusta</i>	3	<i>Prunus avium</i>	8
<i>Betula alleghaniensis</i>	8	<i>Guarea cedrata</i>	7	<i>Pseudotsuga menzesii</i>	2
<i>Betula pendula</i>	8	<i>Guarea thomsonii</i>	8	<i>Pterocarpus angolensis</i>	6
<i>Betula spp</i>	8	<i>Guibortia ehie</i>	2	<i>Pterocarpus indicus</i>	6
<i>Bosquiera phoberos</i>	1	<i>Hevea brasiliensis</i>	7	<i>Pterocarpus soyauxii</i>	5
<i>Brachylaena hutchinsii</i>	8	<i>Intsia bijuga</i>	2	<i>Pterygota bequaertii</i>	1
<i>Brachystegia spp</i>	2	<i>Juglans nigra</i>	1	<i>Quercus cerris</i>	4
<i>Calophyllum brasiliense</i>	7	<i>Juglans regia</i>	3	<i>Quercus delegatensis</i>	3
<i>Canarium schweinfurthii</i>	2	<i>Khaya ivorensis</i>	8	<i>Quercus gigantean</i>	3
<i>Cardwellia sublimes</i>	3	<i>Khaya senegalensis</i>	4	<i>Quercus robur</i>	1
<i>Carya glabra</i>	5	<i>Larix decidua</i>	3	<i>Quercus spp</i>	1
<i>Cassipourea elliotii</i>	5	<i>Larix kaempferi</i>	3	<i>Ricinodendron heudelotti</i>	5
<i>Cassipourea melanosana</i>	5	<i>Larix leptolepis</i>	3	<i>Sarcocephalus diderrichii</i>	7

Castanea sutiva	3	Larix occidentalis	5	Scottellia coriacea	4
Cedrela odorata	8	Liquidambar styraciflua	1	Sequoia sempervirens	2
Ceratopetalum apetala	6	Lovoa klaineana	8	Shorea spp	2
Chamaecyparis spp (18-28%mc)	3	Lovoa trichiloides	8	Sterculia rhinopetala	1
Chamaecyparis spp (8-18%mc)	8	Maesopsis eminii	8	Swietenia candollei	1
Chlorophora excelsa	5	Mansonia altissima	2	Swietenia mahogani	2
Cordia alliodora	5	Millettia stuhimannii	1	Syncarpia glomulifera	3
Croton megalocarpus	8	Mimusops heckelii	2	Syncarpia laurifolia	3
Cryptomelia japonica	2	Mitragyna ciliata	4	Tarrietia utilis	3
Cupressus spp	1	Nauclea diderrichii	7	Taxus baccata	3
Dacrydium franklinii	2	Nesogordonia papaverifera	3	Tectona grandis	5
Dalbergia latifolia	1	Nothofagus cunninghamii	1	Terminalia superba	1
Diospyros virginiana	6	Ochroma pyramidalis	1	Thuja plicata	3
Dipterocarpus (Keruing)	5	Ocotea rodiaei	3	Thujopsis dolabrata	8
Dipterocarpus zeylanicus	1	Ocotea usambarensis	3	Tieghamella heckelii	2
Distemonanthus benthamianus	3	Octomeles sumatrana	4	Tilia americana	6
Dracontomelum mangiferum	2	Olea hochstetteri	2	Tilia vulgaris	4
Dryobalanops spp	1	Olea welwitschii	3	Triplohiton scleroxylon	6
Dyera costulata	3	Palaquium spp	1	Tsuga heterophylla	3
Endiandra palmerstoni	3	Paulownia tomentosa	8	Ulmus americana	4
Entandrophragma angolense	7	Pericopsis elata	6	Ulmus procera	4
Entandrophragma cylindricum	3	Picaenia excelsa	3	Ulmus thomasii	4
Entandrophragma utile	8	Picea abies	3	Xylia dolabriformis	4
Erythrophleum spp	3	Picea jezoensis (18-28%mc)	3	Zelkova serrata	2

### 9.3 %WME Table (% Wood Moisture Equivalent)

Material Wood Group Nos.								
1	2	3	4	5	6	7	8	9
%WME (percent wood moisture equivalent)								
7	8.2	9	8	7.1	7	11	10.5	-
8	10	10.5	9.3	7.5	7.4	11.5	11	-
9	10.8	10.9	9.7	7.9	8.1	12.1	11.6	8.5
10	11.7	11.5	10.4	8.6	8.8	12.7	12.2	9.4
11	12.7	12.6	11.3	9.5	9.7	13.4	13.4	10.5
12	13.6	13.7	12.1	10.5	10.5	14	14.3	11.5
13	14.5	14.5	12.7	11.2	11.2	14.5	15.1	12.5
14	15.3	15.5	13.4	11.8	11.8	15	16	13.5
15	16.3	16.7	14.1	12.5	12.6	15.6	17	14.4
16	16.9	17.5	14.8	13	13.2	16	17.7	14.9
17	17.7	18.8	15.7	14.3	13.9	16.6	18.5	15.3
18	18.2	19.7	16.3	15	14.5	17	19.1	16.1
19	19	21	16.9	15.9	15.2	17.6	20	16.7
20	20	22.6	17.8	16.9	16.1	18.4	21.3	17.2
21	20.8	23.5	18.5	17.6	16.8	19.1	22.3	18.3
22	21.5	24.5	19.3	18.3	17.4	19.7	23.2	19.1
23	22.9	26.4	20.2	19.8	18.6	21.2	25.3	19.9
24	23.5	27.4	20.8	20.4	19	22	25.8	20.5
25	24.2	27.8	21.2	21	19.4	22.7	26.3	≈23
26	25.3	29	22.4	22.3	20.1	23.9	27.3	-
27	26.5	-	23.3	23.4	20.8	24.7	28.1	-
28	28	-	24.4	24.8	21.7	25.9	-	-
29	29.6	-	25.6	26.3	22.9	27.1	-	-

## 10. Warranty

---

### 10.1 FLIR Test & Measurement 2-Year Limited Warranty

Congratulations! You (the “Purchaser”) are now the owner of a world-class FLIR Test and Measurement product. A qualifying FLIR Test and Measurement product (the “Product”) purchased either directly from FLIR Commercial Systems Inc. and affiliates (FLIR) or from an authorized FLIR distributor that Purchaser registers on-line with FLIR is eligible for coverage under FLIR’s 2-Year Limited Warranty subject to the terms and conditions in this document. This warranty only applies to purchases of Qualifying Products (see below) purchased after June 2016 and only to the original Purchaser of the Product.

PLEASE READ THIS DOCUMENT CAREFULLY; IT CONTAINS IMPORTANT INFORMATION ABOUT THE PRODUCTS THAT QUALIFY FOR COVERAGE UNDER THE 2-YEAR LIMITED WARRANTY, PURCHASER’S OBLIGATIONS, HOW TO ACTIVATE THE WARRANTY, WARRANTY COVERAGE, AND OTHER IMPORTANT TERMS, CONDITIONS, EXCLUSIONS AND DISCLAIMERS.

**1. PRODUCT REGISTRATION.** To qualify for FLIR’s 2-Year Limited Warranty, the Purchaser must fully register the Product directly with FLIR on-line at [www.flir.com](http://www.flir.com) WITHIN Sixty (60) DAYS of the date the Product was purchased by the first retail customer (the “Purchase Date”). PRODUCTS THAT ARE NOT REGISTERED ON-LINE WITHIN Sixty (60) DAYS OF THE PURCHASE DATE OR PRODUCTS WHICH DO NOT QUALIFY FOR THE 2-YEAR WARRANTY WILL HAVE A LIMITED ONE YEAR WARRANTY FROM THE DATE OF PURCHASE.

**2. QUALIFYING PRODUCTS.** Upon registration, a list of Test and Measurement Products that qualify for coverage under FLIR’s 2-Year Limited Warranty can be found at [www.flir.com/testwarranty](http://www.flir.com/testwarranty)

**3. THE WARRANTY PERIOD.** The Product is warranted for a period of two (2) Years from the Purchase Date (the “Warranty Period”).

Any Product that is repaired or replaced under warranty is covered under this 2-Year Limited Warranty for one hundred eighty days (180) days from the date of return shipment by FLIR or for the remaining duration of the applicable Warranty Period, whichever is longer.

**4. LIMITED WARRANTY.** In accordance with the terms and conditions of this 2-Year Limited Warranty, and except as excluded or disclaimed in this document, FLIR warrants, from the Purchase Date, that all fully registered Products will conform to FLIR’s published Product specifications and be free from defects in materials and workmanship during the applicable Warranty Period. PURCHASER’S SOLE AND EXCLUSIVE REMEDY UNDER THIS WARRANTY, AT FLIR’S SOLE DISCRETION, IS THE REPAIR OR REPLACEMENT OF DEFECTIVE PRODUCTS IN A MANNER, AND BY A SERVICE CENTER, AUTHORIZED BY FLIR. IF THIS REMEDY IS ADJUDICATED TO BE INSUFFICIENT, FLIR SHALL REFUND PURCHASER’S PAID PURCHASE PRICE AND HAVE NO OTHER OBLIGATION OR LIABILITY TO BUYER WHATSOEVER.

**5. WARRANTY EXCLUSIONS AND DISCLAIMERS.** FLIR MAKES NO OTHER WARRANTY OF ANY KIND WITH RESPECT TO THE PRODUCTS. ALL OTHER WARRANTIES, EXPRESS OR IMPLIED, INCLUDING BUT NOT LIMITED TO IMPLIED WARRANTIES OF MERCHANTABILITY, FITNESS FOR A PARTICULAR PURPOSE (EVEN IF PURCHASER HAS NOTIFIED FLIR OF ITS INTENDED USE FOR THE PRODUCTS), AND NON-INFRINGEMENT ARE EXPRESSLY EXCLUDED FROM THIS AGREEMENT.

THIS WARRANTY EXPRESSLY EXCLUDES ROUTINE PRODUCT MAINTENANCE, AND SOFTWARE UPDATES. FLIR FURTHER EXPRESSLY DISCLAIMS ANY WARRANTY COVERAGE WHERE THE ALLEGED NONCONFORMITY IS DUE TO NORMAL WEAR AND TEAR OTHER THAN SENSORS, ALTERATION, MODIFICATION, REPAIR, ATTEMPTED REPAIR, IMPROPER USE, IMPROPER MAINTENANCE, NEGLIGENCE, ABUSE, IMPROPER STORAGE, FAILURE TO FOLLOW ANY PRODUCT INSTRUCTIONS, DAMAGE (WHETHER CAUSED BY ACCIDENT OR OTHERWISE), OR ANY OTHER IMPROPER CARE OR HANDING OF THE PRODUCTS CAUSED BY ANYONE OTHER THAN FLIR OR FLIR’S EXPRESSLY AUTHORIZED DESIGNEE.

THIS DOCUMENT CONTAINS THE ENTIRE WARRANTY AGREEMENT BETWEEN PURCHASER AND FLIR AND SUPERSEDES ALL PRIOR WARRANTY NEGOTIATIONS, AGREEMENTS, PROMISES AND UNDERSTANDINGS BETWEEN PURCHASER AND FLIR. THIS WARRANTY MAY NOT BE ALTERED WITHOUT THE EXPRESS WRITTEN CONSENT OF FLIR.



**6. WARRANTY RETURN, REPAIR AND REPLACEMENT.** To be eligible for warranty repair or replacement, Purchaser must notify FLIR within thirty (30) days of discovering of any apparent defect in materials or workmanship. Before Purchaser may return a Product for warranty service or repair, Purchaser must first obtain a returned material authorization (RMA) number from FLIR. To obtain the RMA number Owner must provide an original proof of purchase. For additional information, to notify FLIR of an apparent defect in materials or workmanship, or to request an RMA number, visit [www.flir.com](http://www.flir.com). Purchaser is solely responsible for complying with all RMA instructions provided by FLIR including but not limited to adequately packaging the Product for shipment to FLIR and for all packaging and shipping costs. FLIR will pay for returning to Purchaser any Product that FLIR repairs or replaces under warranty.

FLIR reserves the right to determine, in its sole discretion, whether a returned Product is covered under warranty. If FLIR determines that any returned Product is not covered under warranty or is otherwise excluded from warranty coverage, FLIR may charge Purchaser a reasonable handling fee and return the Product to Purchaser, at Purchaser's expense, or offer Purchaser the option of handling the Product as a non-warranty return. FLIR shall not be responsible for any data, images or other information that may be stored on the returned Product which was not included in the Product at the time of purchase. It is Purchaser's responsibility to save any and all data prior to returning the Product for warranty service.

**7. NON-WARRANTY RETURN.** Purchase may request that FLIR evaluate and service or repair a Product not covered under warranty, which FLIR may agree to do in its sole discretion. Before Purchaser returns a Product for non-warranty evaluation and repair, Purchaser must contact FLIR by visiting [www.flir.com](http://www.flir.com) to request an evaluation and obtain an RMA. Purchaser is solely responsible for complying with all RMA instructions provided by FLIR including but not limited to adequately packaging the Product for shipment to FLIR and for all packaging and shipping costs. Upon receipt of an authorized non-warranty return, FLIR will evaluate the Product and contact Purchaser regarding the feasibility of and the costs and fees associated with Purchaser's request. Purchaser shall be responsible for the reasonable cost of FLIR's evaluation, for the cost of any repairs or services authorized by Purchaser, and for the cost of repackaging and returning the Product to Purchaser. Any non-warranty repair of a Product is warranted for one hundred eighty days (180) days from the date of return shipment by FLIR to be free from defects in materials and workmanship only, subject to all of the limitations, exclusions and disclaimers in this document.



---

## Corporate Headquarters

FLIR Systems, Inc.  
2770 SW Parkway Avenue  
Wilsonville, OR 97070  
USA  
Telephone: +1 503-498-3547

## Customer Support

Technical Support Website	<a href="http://support.flir.com">http://support.flir.com</a>
Technical Support Email	<a href="mailto:TMSupport@flir.com">TMSupport@flir.com</a>
Service and Repair Email	<a href="mailto:Repair@flir.com">Repair@flir.com</a>
Customer Support Telephone	+1 855-499-3662 option 3 (toll free)

## Firmware Updates

To check for MR60 firmware updates please visit the technical support website (above) for complete installation instructions.

Publication Identification No.:	MR60-en-US
Release Version:	AB
Release Date:	2016 May
Language:	en-US